

Tools

F45

FT

FS

FL

FLP

F65

FM

FMP

F85

F85P

FH

FK

FKP

FB140

FB175

FB295

SPIRAL

FW

FLX

FMX

FHX

FBX175

FBX295

ACC

CA

FC

TOOL

IDX

Contents

Pin insertion tool 3

Rivet crimping pliers 3

Mounting tool 4

Rivet crimping clamp 4

Drill fixture 4



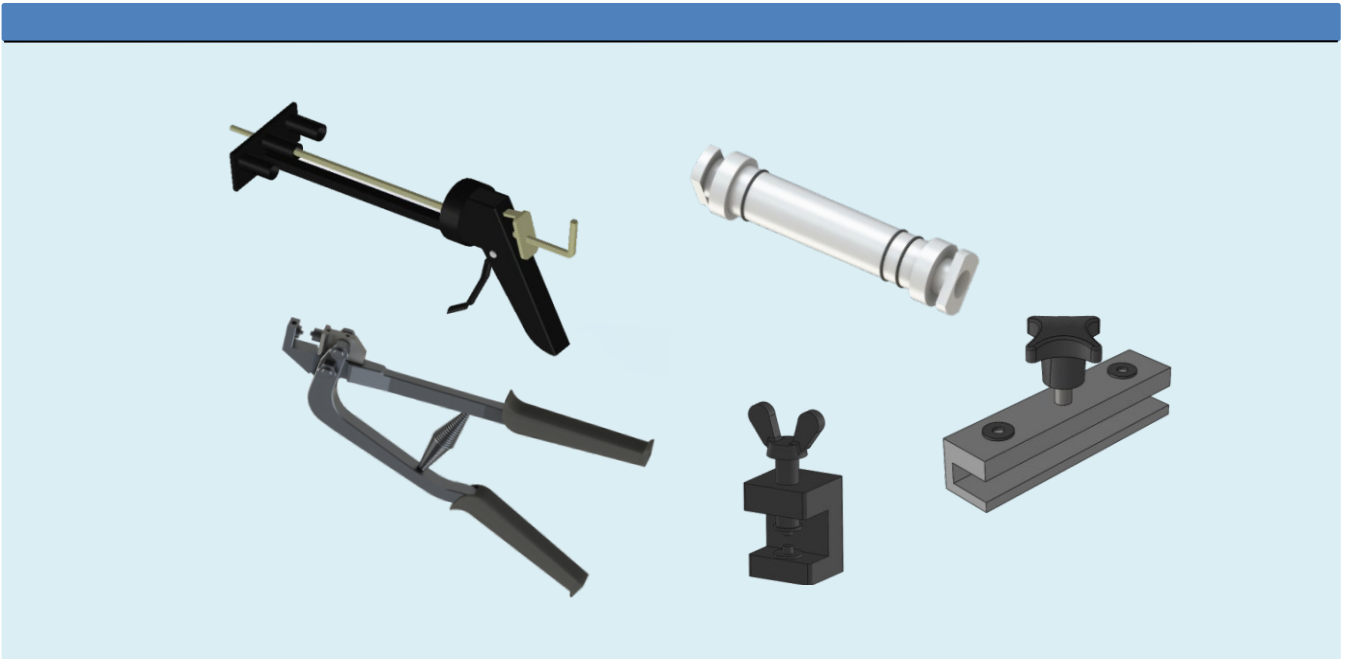

Washer cleaner 4

Bending Machine 4

Tools

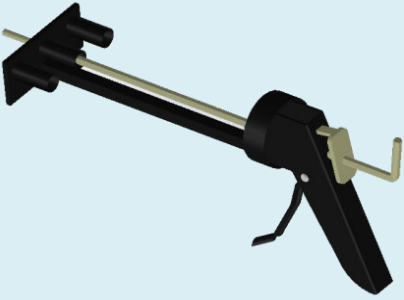

Tools

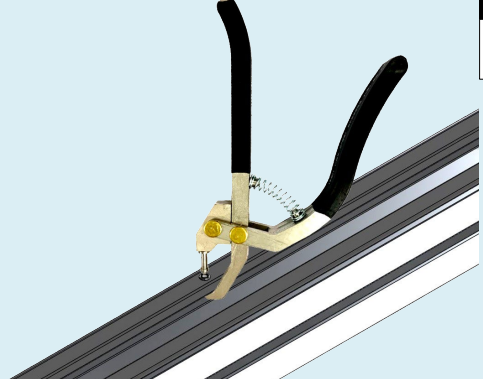
<p>Pin insertion tool</p> <p>FLMJ 4 For FS, FL FMMJ 6 For FM FHMJ 6 For FH</p>		<p>F45 FT FS FL FLP F65 FM</p>
<p>Pin insertion tool</p> <p>FKMJ 8 For FK FBMJ 6 For FB 140, 175, 295</p>		<p>FMP F85 F85P FH FK FKP</p>
<p>Pin insertion tool</p> <p>FBMJ 6P For FM, FH, F85, FB140</p>		<p>FB140 FB175 FB295 SPIRAL FW FLX FMX</p>
<p>Rivet crimping pliers</p> <p>F5051395 For FL, FM, FH F3924776 For FS</p>		<p>FHX FBX175 FBX295 ACC CA FC</p>
<p>Rivet crimping pliers</p> <p>F3923563 For F45</p>		<p>TOOL IDX</p>

Tools

Traffic police man

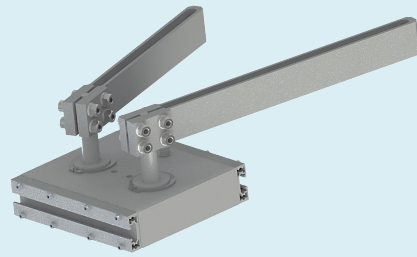

Mounting tool

FLMR 140 For FS & FL
FMMR 140 For FM & FB140
FHMR 200 For FH
FKMR 200 For FK
FBMR 170 For F85, FB175 & 295

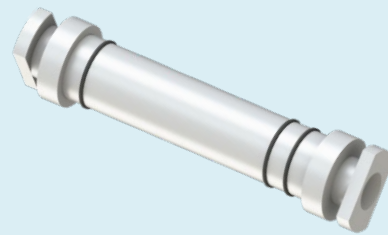

Rivet crimping clamp

F3923005 For FL, FM, FH
F3924770 For FS

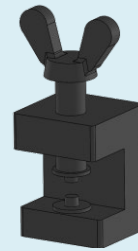

Drill fixture

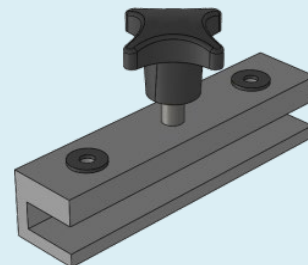

F3924774 For FS
F3920500 For FL, FM, FH

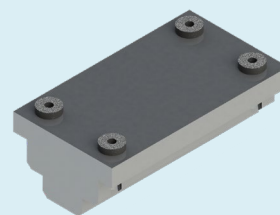

F3923584 For F45

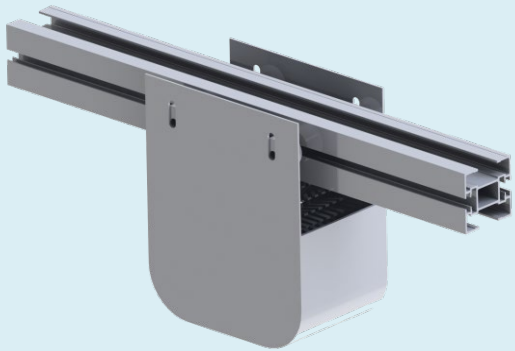
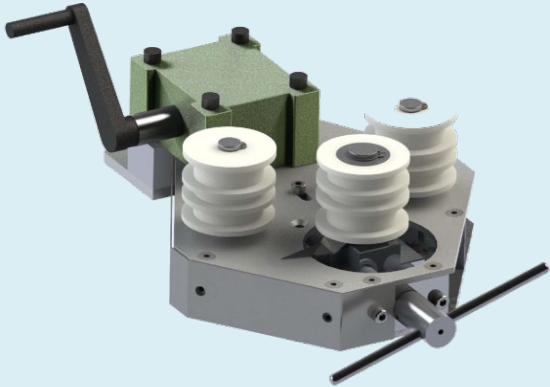
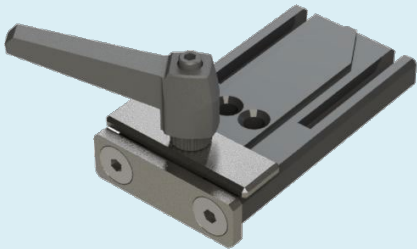

Tools

<p>Washer cleaner</p>		<p>F45 FT FS FL FLP F65 FM FMP</p>
<p>Bending Machine F3922963</p>		<p>F85 F85P FH FK FKP FB140 FB175 FB295</p>
<p>Drill fixture F5116761 For F65 For the connection bracket hole pattern</p>		<p>SPIRAL FW FLX FMX FHX FBX175 FBX295</p>
<p>Mounting tool for slide rail FWMR 135</p>		<p>ACC CA FC TOOL IDX</p>

